

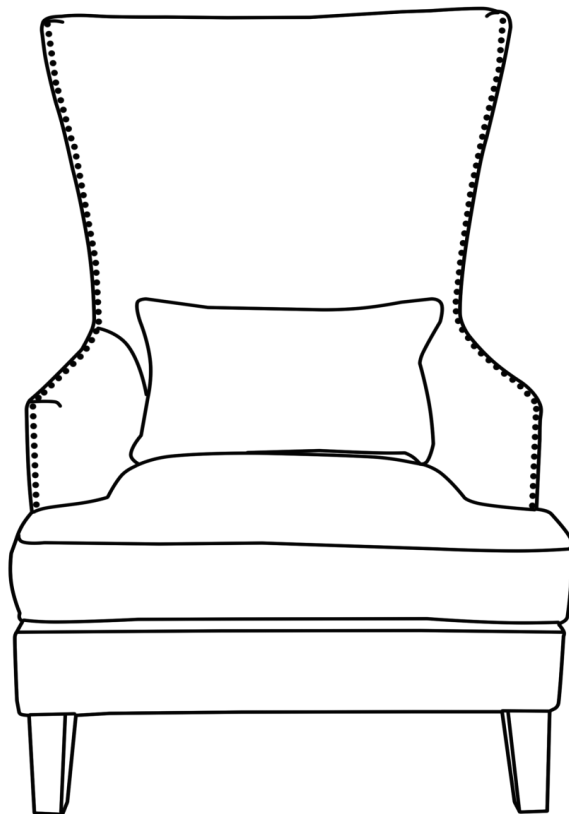



**Bristol Chair
TOV-A89/TOV-A102**

BRISTOL





ASSEMBLY INSTRUCTIONS



PARTS LIST

LABEL	PICTURE	Description	QTY
A		Chair	1
B		Front Leg	2
C		Back Leg	2

HARDWARE

LABEL	PICTURE	Description	QTY
E		Metal Gasket	8
F		Spring Washer	8
G		Bolt	8
H		Wrench	1

BEFORE BEGINNING ASSEMBLY:



Read instructions cover to cover



Have two adults on hand for assembly



Do NOT assemble on flooring or carpet. Assemble on a clean non-marring surface (ex: packing foam)



Save all packaging until assembly is completed

ASSEMBLY STEPS

STEP 1

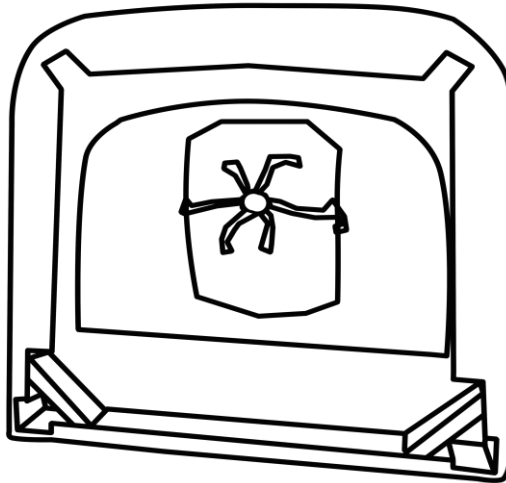

- › Position the product on its bottom as shown.
- › Open to take the four legs.

STEP 2

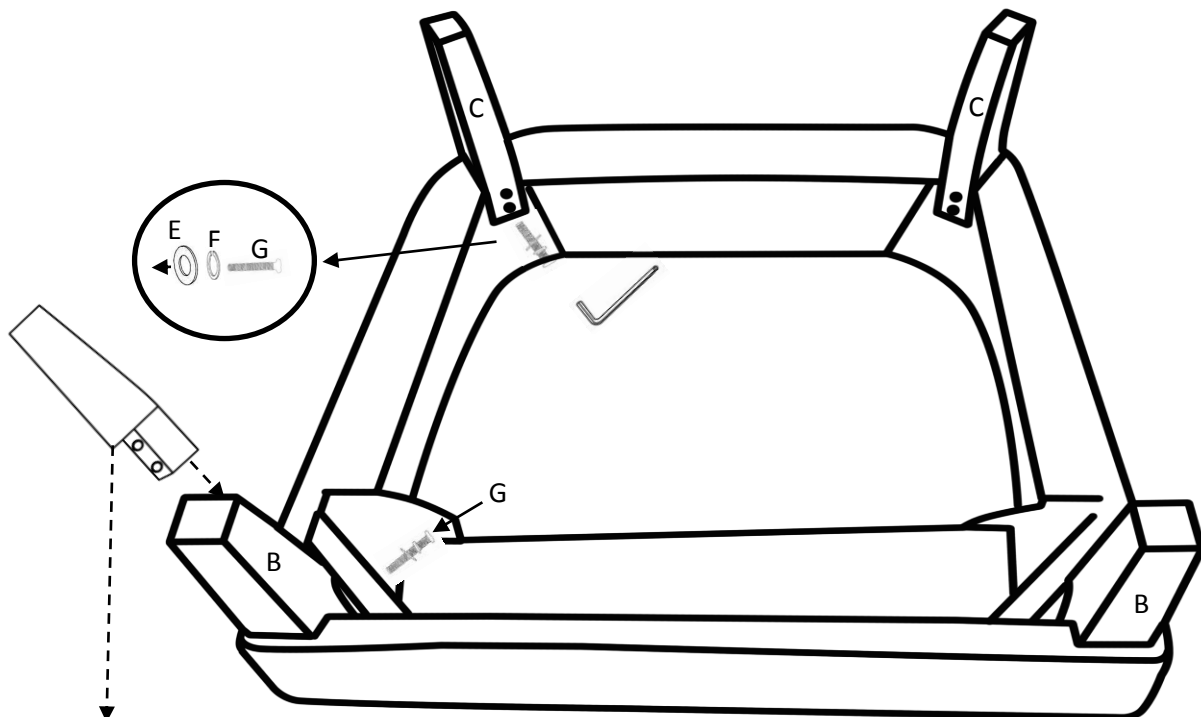

According the "Inner" Label sticker on leg , please make sure the leg bevel face is inside

CARE & MAINTENANCE



Do not put hot items directly on furniture surface.



Do not clean furniture with harsh cleansers or polish.



Dust and pick up spills using a clean, non-colored, lint-free cloth.



Stains may be removed with mild soap solution and a damp cloth.



Do not place furniture under direct sunlight.



Do not place furniture near heating or cooling vents.



Do not write on furniture without a padded barrier to protect the surface.



Do not place furniture outside, for indoor use only.