

T Ö V

FURNITURE

Assembly Instructions

Ella Chest

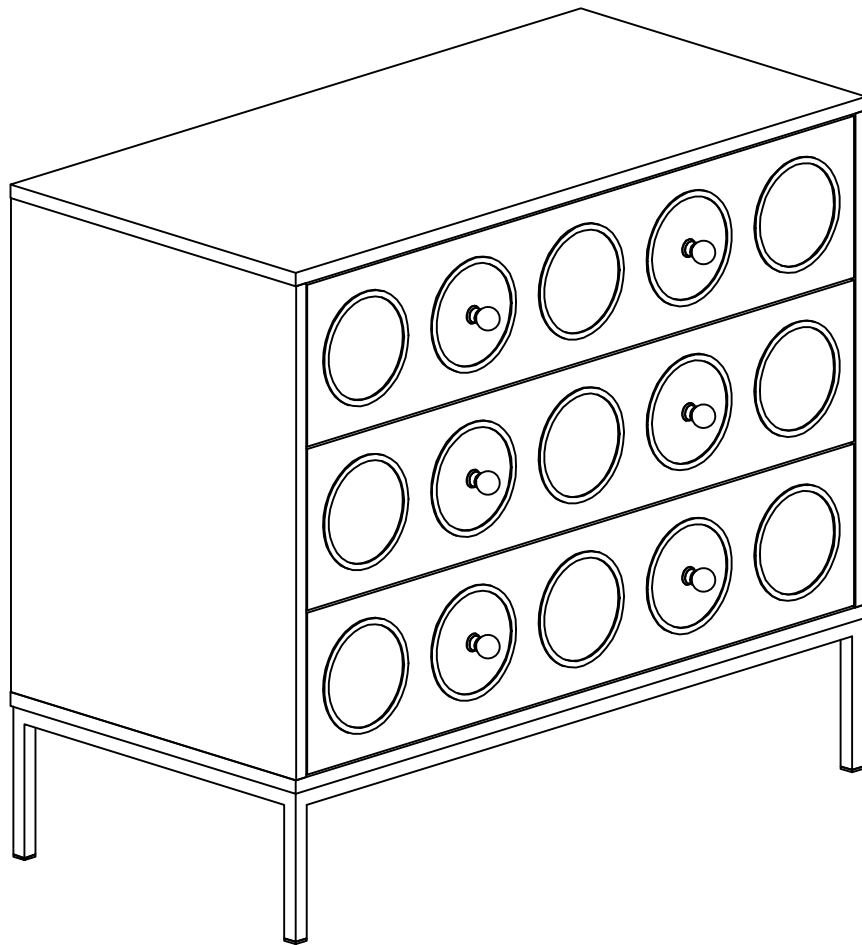

Parts List

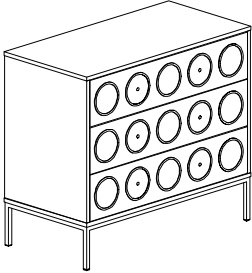



Label	Picture	Description	QTY
A		Cabinet Body	1

Hardware

Label	Picture	Description	QTY

Assembly Preparation

Before Beginning Assembly:







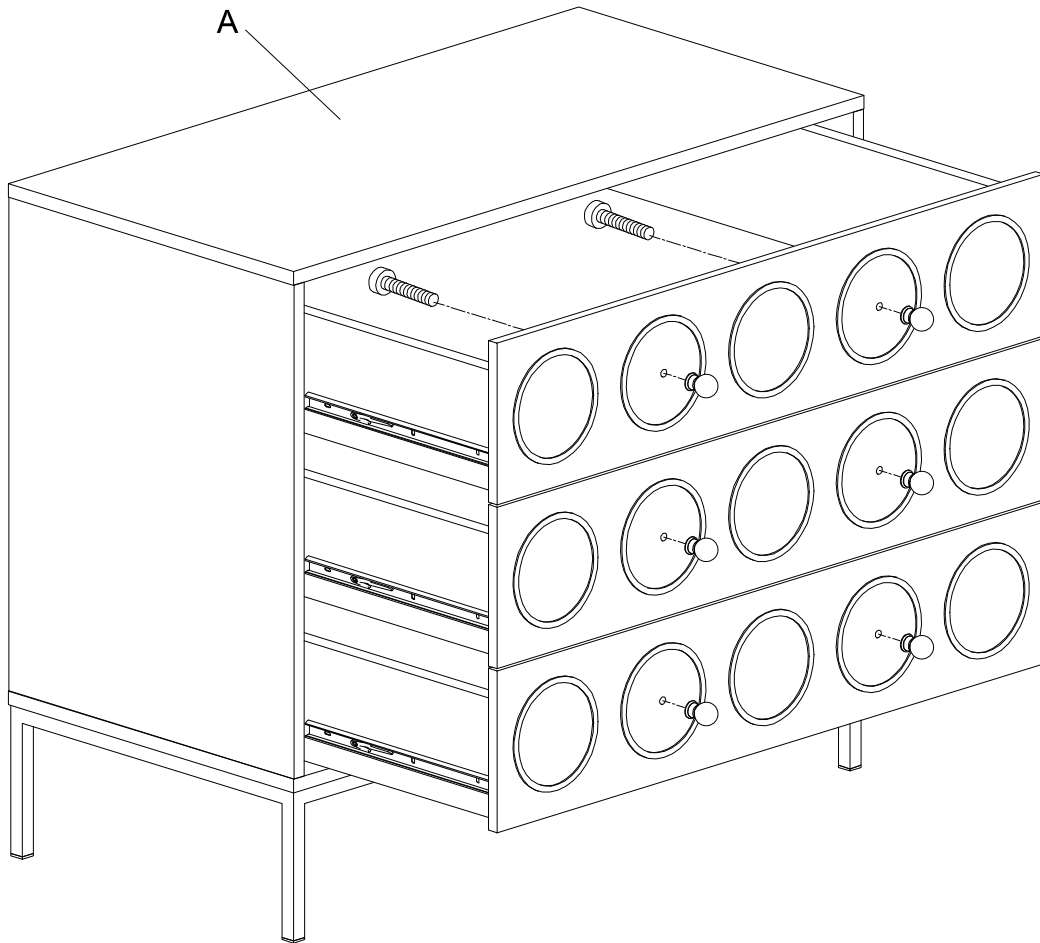

-  • Read instructions, cover to cover-
-  • Have 2 adults on hand for assembly-
-  • Do not assemble on flooring or carpet-
-  • Assemble on a clean non-marring surface (packing foam)-
-  • Save all packaging until finished-

Assembly Steps

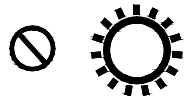
Step 1



Care & Maintenance

-  • Do not put hot items directly on furniture surface.
 -  • Do not clean furniture with harsh cleansers or polish.
 -  • Do not place furniture under direct sunlight.
 -  • Do not place furniture near heating or cooling vents.
 -  • Do not write on furniture without a padded barrier to protect the surface.
 -  • Do not place furniture outside. For indoor use only.
 -  • Not for commercial use. For residential use only.
 -  • Stains may be removed with mild soap solution and damp cloth.
-
-  • Dust and pick-up spills using a clean, non-colored, lint-free cloth.