

TÖV
FURNITURE

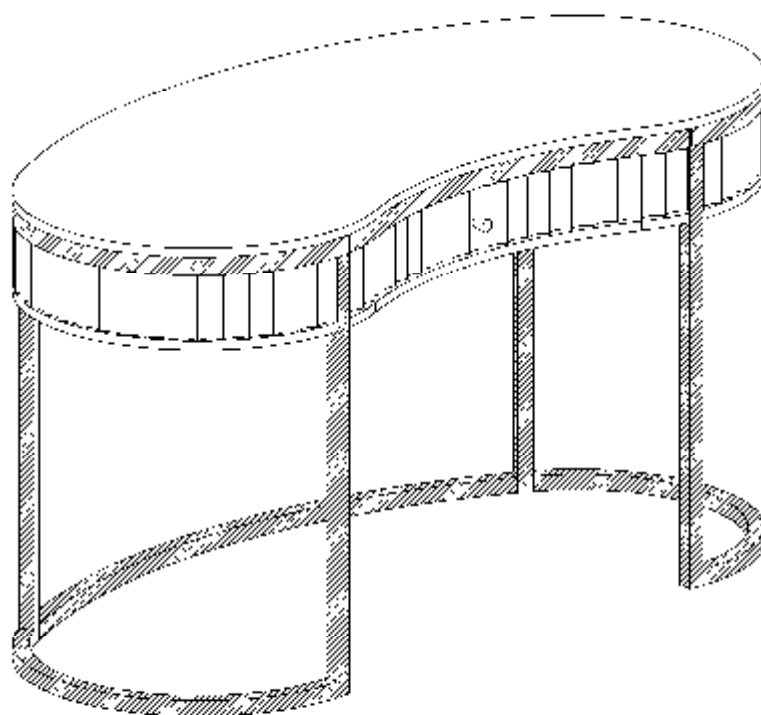



Cascade Writing Desk
TOV-GH5508

CASCADE







ASSEMBLY INSTRUCTIONS



PARTS LIST

LABEL	PICTURE	DESCRIPTION	QTY
A		Top	1
B		Left Side Frame	1
C		Right Side Frame	1
D		Crossing Bar	1

HARDWARE

LABEL	PICTURE	DESCRIPTION	QTY
D		Screw M6*12	2
E		Screw M6*20	8
F		Screw M6*25	2
G		Spring Shim M6	10
H		Washer Ø(16-6)*1.5	12
I		Allen Key Ø4	1

BEFORE BEGINNING ASSEMBLY:



Read instructions cover to cover



Have two adults on hand for assembly



Do NOT assemble on flooring or carpet. Assemble on a clean non-marring surface (ex: packing foam)



Save all packaging until assembly is completed

ASSEMBLY STEPS

STEP 1

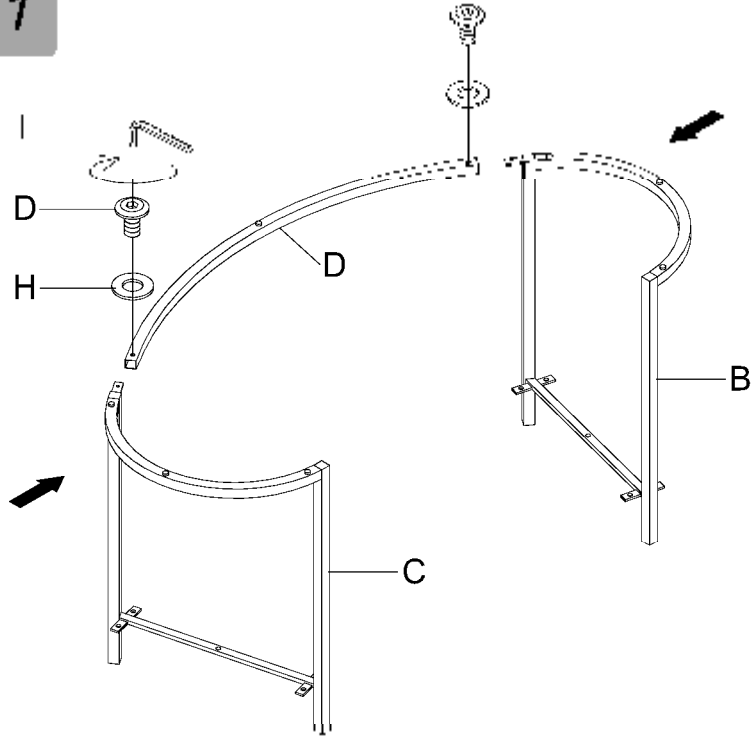

STEP 2

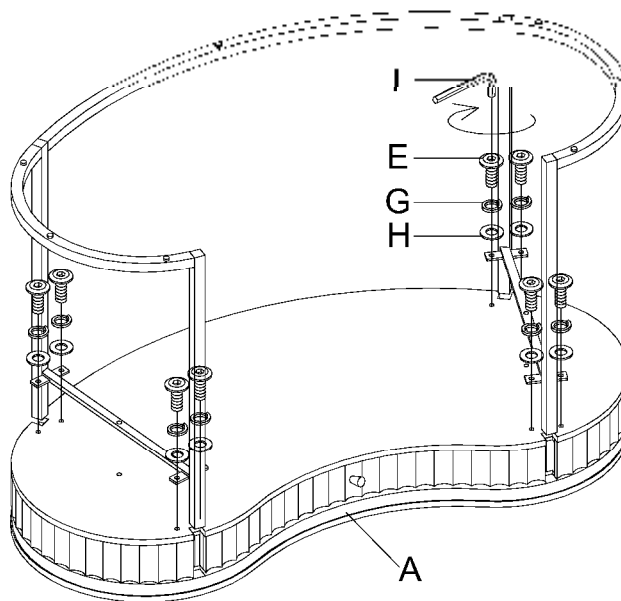

ASSEMBLY STEPS

STEP 3

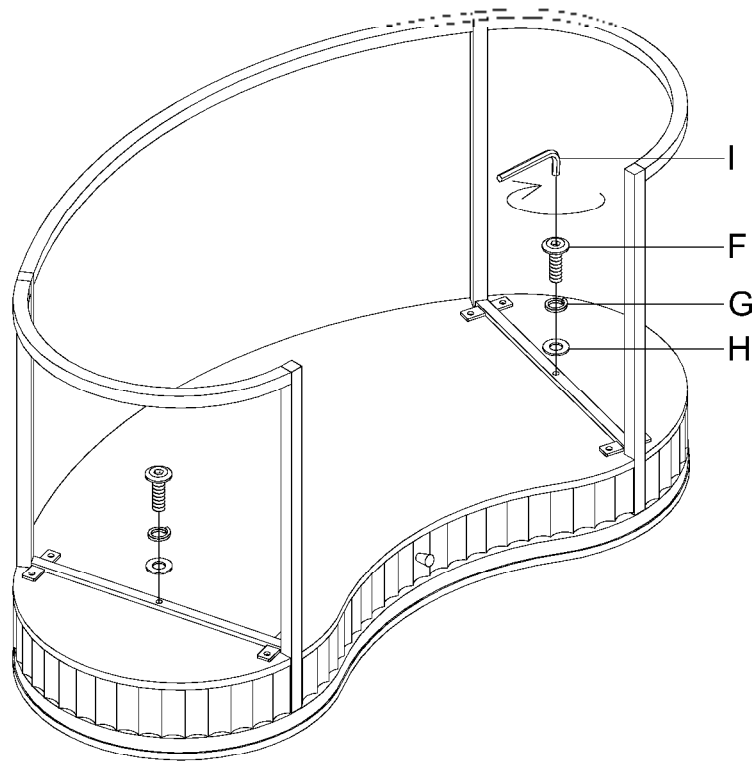

CARE & MAINTENANCE



Do not put hot items directly on furniture surface.



Do not clean furniture with harsh cleansers or polish.



Dust and wipe up spills using a clean, non-colored, lint-free cloth.



Stains may be removed with mild soap solution and damp cloth.



Do not place furniture under direct sunlight.



Do not place furniture near heating or cooling vents.



Do not write on furniture without a padded barrier to protect the surface.



Do not place furniture outside. For indoor use only.