

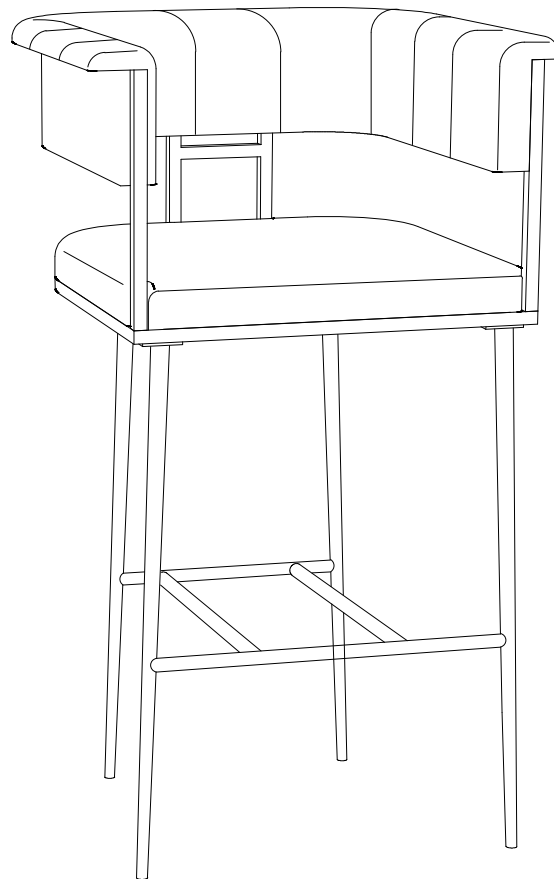



ASTRID VELVET BAR STOOL
TOV- D44027/D44028

ASTRID

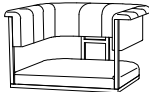

ASSEMBLY INSTRUCTIONS



PARTS LIST

LABEL	PICTURE	DESCRIPTION	QTY.
A		CHAIR	1
B		FRONT LEGS	1
C		BACK LEGS	1
D		STRETCHER	2

HARDWARE

LABEL	PICTURE	DESCRIPTION	QTY.
1		M6 x 15	20
2		SPRING WASHER M6	16
3		ALLEN KEY K4	1

BEFORE BEGINNING ASSEMBLY :



Read instructions cover to cover



Have two adults on hand for assembly



Do NOT assemble on flooring or carpet. Assemble on a clean non-marring surface (ex: packing foam)



Save all packaging until assembly is completed

ASSEMBLY STEPS

STEPS 1

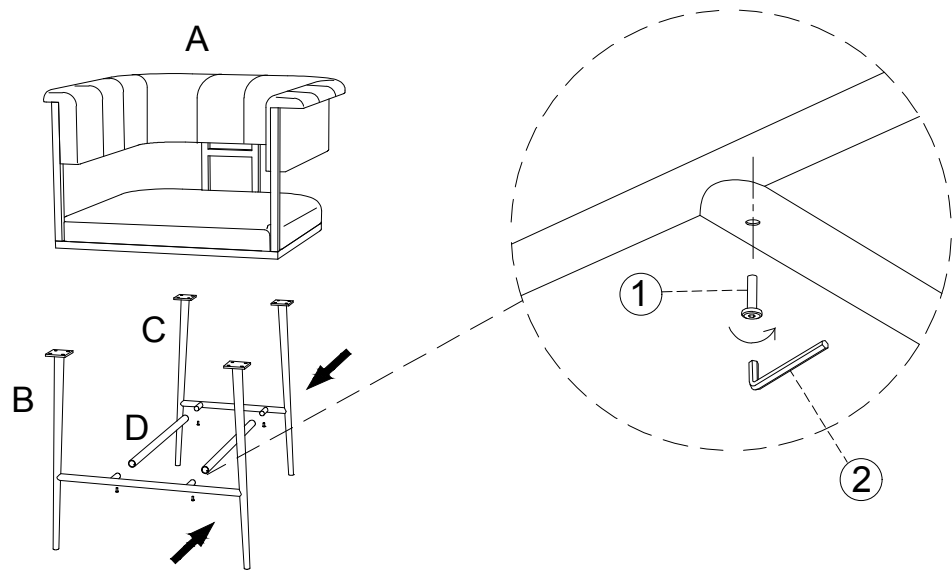

Attached the 2 stretcher to the leg rail with the M6 x 15 bolt.



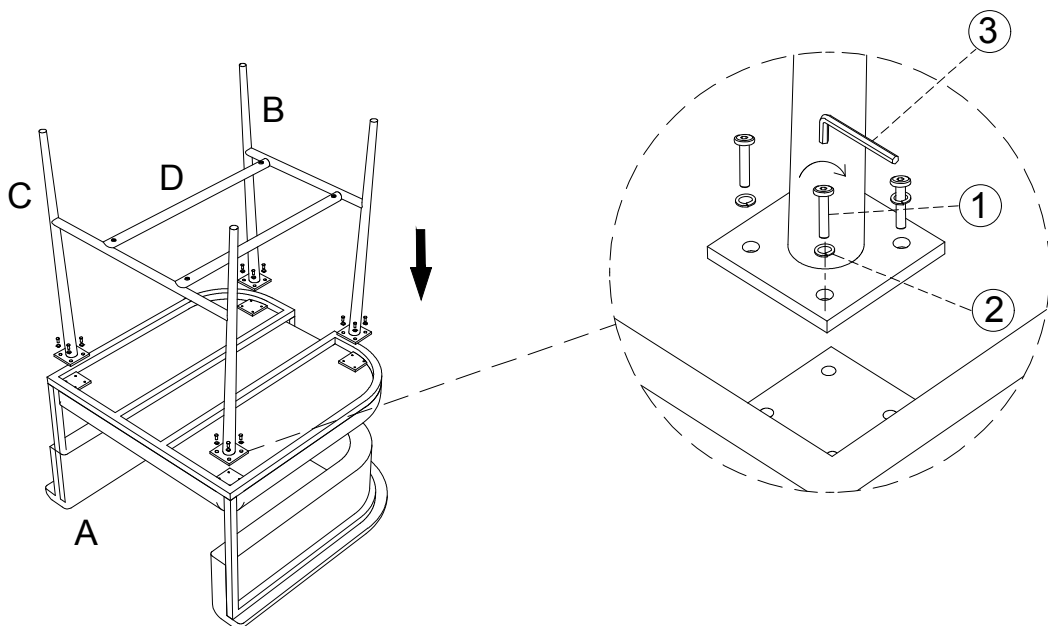





STEPS 2



> Position the legs on the chair bottom as shown.

Keep the bolts loose during setup and tighten once all 4 legs are aligned properly.

CARE & MAINTENANCE

-  Do not put hot items directly on furniture surface.
-  Do not clean furniture with harsh cleansers or polish.
-  Dust and wipe up spills using a clean, non- colored, lint-free cloth.
-  Stains may be removed with mild soap solution and a damp cloth.
-  Do not place furniture under direct sunlight.
-  Do not place furniture near heating or cooling vents.
-  Do not write on furniture without a padded barrier to protect the surface.
-  Do not place furniture outside, for indoor use only.

CARE & MAINTENANCE FOR FABRIC



Advise dry-cleaning only.

In case of stains , use a clean towel with some warm water.

Chemicals are not advised.