

T O V  
FURNITURE

# DAISY PETITE VELVET SOFA

TOV-L4918/TOV-L4919/TOV-L4920



# DAISY

---

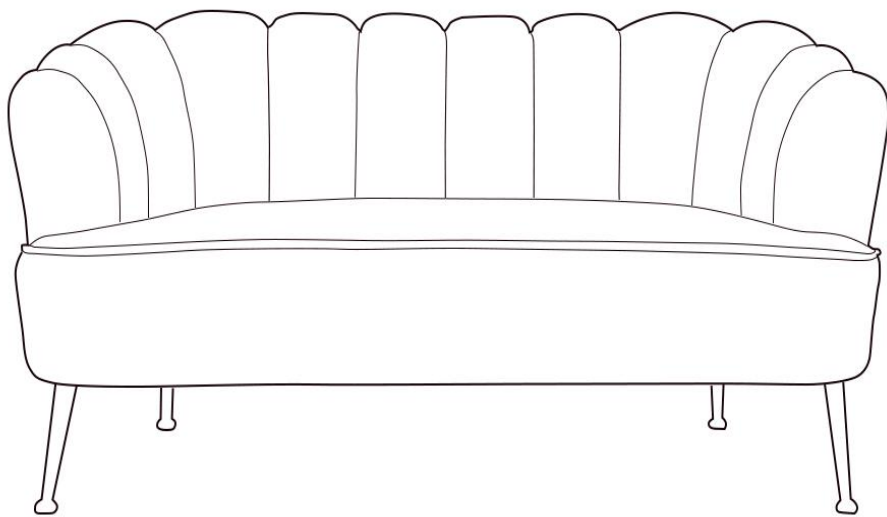

## ASSEMBLY INSTRUCTIONS

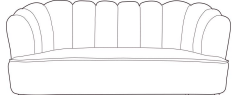





## PARTS LIST

LABEL	PICTURE	DESCRIPTION	QTY
A		SOFA	1
B		LEG	4

## HARDWARE

LABEL	PICTURE	DESCRIPTION	QTY
C		bolt	12
D		wrench	1

### BEFORE BEGINNING ASSEMBLY:

-  Read instructions cover to cover
-  Have two adults on hand for assembly
-  Do NOT assemble on flooring or carpet. Assemble on a clean non-marring surface (ex: packing foam)
-  Save all packaging until assembly is completed

## ASSEMBLY STEPS

### STEP 1

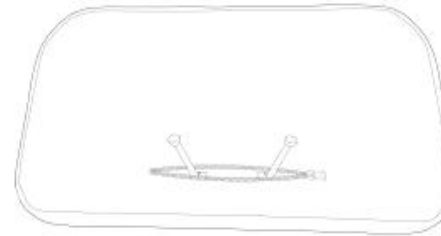

- > Position the product on its bottom as shown.
- > Open to take the four legs.

### STEP 2

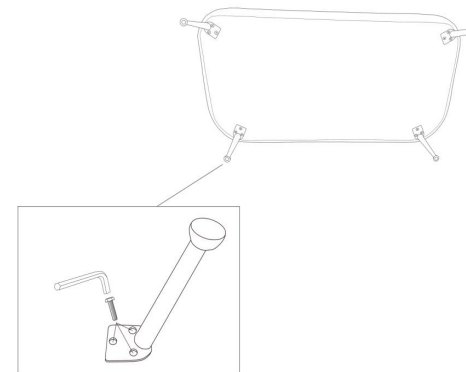

- > Please find the hole which marked at bottom. Put legs at the right location.
- > Fix the screws by wrench on the hole one by one. Total 3 screws for one leg.
- > Fix other legs as the same way as first one